

FB

Технические характеристики

По вопросам продаж и поддержки обращайтесь:

Алматы (7273)495-231	Казань (843)206-01-48	Новокузнецк (3843)20-46-81	Смоленск (4812)29-41-54
Архангельск (8182)63-90-72	Калининград (4012)72-03-81	Новосибирск (383)227-86-73	Сочи (862)225-72-31
Астрахань (8512)99-46-04	Калуга (4842)92-23-67	Омск (3812)21-46-40	Ставрополь (8652)20-65-13
Барнаул (3852)73-04-60	Кемерово (3842)65-04-62	Орел (4862)44-53-42	Сургут (3462)77-98-35
Белгород (4722)40-23-64	Киров (8332)68-02-04	Оренбург (3532)37-68-04	Тверь (4822)63-31-35
Брянск (4832)59-03-52	Краснодар (861)203-40-90	Пенза (8412)22-31-16	Томск (3822)98-41-53
Владивосток (423)249-28-31	Красноярск (391)204-63-61	Пермь (342)205-81-47	Тула (4872)74-02-29
Волгоград (844)278-03-48	Курск (4712)77-13-04	Ростов-на-Дону (863)308-18-15	Тюмень (3452)66-21-18
Вологда (8172)26-41-59	Липецк (4742)52-20-81	Рязань (4912)46-61-64	Ульяновск (8422)24-23-59
Воронеж (473)204-51-73	Магнитогорск (3519)55-03-13	Самара (846)206-03-16	Уфа (347)229-48-12
Екатеринбург (343)384-55-89	Москва (495)268-04-70	Санкт-Петербург (812)309-46-40	Хабаровск (4212)92-98-04
Иваново (4932)77-34-06	Мурманск (8152)59-64-93	Саратов (845)249-38-78	Челябинск (351)202-03-61
Ижевск (3412)26-03-58	Набережные Челны (8552)20-53-41	Севастополь (8692)22-31-93	Череповец (8202)49-02-64
Иркутск (395)279-98-46	Нижний Новгород (831)429-08-12	Симферополь (3652)67-13-56	Ярославль (4852)69-52-93
Россия (495)268-04-70	Киргизия (996)312-96-26-47	Казахстан (7172)727-132	

FB Duct

FB ducting offers a complete range of diameters and accessories for easy-to-fix professional installations.



Manufactured from galvanised steel, which have smoother internal surfaces and provide greatly enhanced leak resistance, FB ducting offers an unbeatable solution for all general purpose dust extraction duties.

-
- **BT for fast installation with no special tools, no painting, flexible working**
 - **Easy to assemble installation components**
 - **Neat slip duct connections to adapt and adjust ducting on site during installation**
 - **Laser welded straight ducts for smoother surface and enhanced leak resistance**
 - **Easy to extend or take apart completely for cleaning, reconfiguring or relocation**

Наименование товара	FB Duct
---------------------	---------

FB Duct

[image]	диаметр (mm)	Length (m)	Вес (кг)	Thickness (mm)	[model]
	80	1500	2,8	0,7	8210004440*
	100	500	0,958	0,7	8210004396*
	100	1000	1,915	0,7	8210004397*
	100	1500	2,8	0,7	8210004398*
	120	500	1,117	0,7	8210004399*
	120	1000	2,234	0,7	8210004400*
	120	1500	3,1	0,7	8210004401*
	125	500	1,179	0,7	8210004402*
	125	1000	2,358	0,7	8210004403*
	125	1500	3,4	0,7	8210004404*
	140	500	1,31	0,7	8210004405*
	140	1000	2,621	0,7	8210004406*
	140	1500	4	0,7	8210004407*
	150	500	1,403	0,7	8210004408*
	150	1000	2,806	0,7	8210004409*

FB Duct

[image]	диаметр (mm)	Length (m)	Вес (кг)	Thickness (mm)	[model]
	150	1500	4,2	0,7	8210004410*
	160	500	1,484	0,7	8210004411*
	160	1000	2,968	0,7	8210004412*
	160	1500	4,5	0,7	8210004413*
	180	500	1,666	0,7	8210004414*
	180	1000	3,332	0,7	8210004415*
	180	1500	5,1	0,7	8210004416*
	200	500	1,834	0,7	8210004417*
	200	1000	3,668	0,7	8210004418*
	200	1500	5,7	0,7	8210004419*
	220	1000	4,116	0,7	8210004420*
	225	500	2,058	0,7	8210004422*
	225	1000	4,116	0,7	8210004423*
	225	1500	6,2	0,7	8210004424*
	250	500	2,282	0,7	8210004425*

FB Duct

[image]	диаметр (mm)	Length (m)	Вес (кг)	Thickness (mm)	[model]
	250	1000	4,564	0,7	8210004426*
	250	1500	7,1	0,7	8210004427*
	300	500	2,716	0,7	8210004428*
	300	1000	5,432	0,7	8210004429*
	300	1500	8,5	0,7	8210004430*
	315	500	2,384	0,9	8210004431*
	315	1000	5,667	0,9	8210004432*
	315	1500	8,8	0,9	8210004433*
	350	500	3,144	0,9	8210004434*
	350	1000	6,289	0,9	8210004435*
	350	1500	9,45	0,9	8210004436*
	400	500	4,608	0,9	8210004437*
	400	1000	8	0,9	8210004438*
	400	1500	13,6	0,9	8210004439*
	80	2000	3,12	0,7	8210004441**

FB Duct

[image]	диаметр (mm)	Length (m)	Вес (кг)	Thickness (mm)	[model]
	100	2000	1,92	0,7	8210004442**
	120	2000	4,47	0,7	8210004443**
	125	2000	4,715	0,7	8210004444**
	140	2000	5,24	0,7	8210004445**
	150	2000	5,61	0,7	8210004446**
	160	2000	5,52	0,7	8210004447**
	180	2000	6,15	0,7	8210004448**
	200	2000	6,9	0,7	8210004449**
	220	2000	7,75	0,7	8210004450**
	225	2000	7,75	0,7	8210004451**
	250	2000	8,62	0,7	8210004452**
	300	2000	10,35	0,7	8210004453**
	315	2000	15,12	0,9	8210004454**
	350	2000	15,52	0,9	8210004455**
	400	2000	17,74	0,9	8210004456**

FB Duct

[image]	диаметр (mm)	Length (m)	Вес (кг)	Thickness (mm)	[model]
	450	500	5,15	0,9	8210004457**
	450	1000	10,3	0,9	8210004458**
	450	2000	19,88	0,9	8210004459**
	500	500	5,56	0,9	8210004460**
	500	1000	11,5	0,9	8210004461**
	500	2000	22,4	0,9	8210004462**
	550	500	6,25	0,9	8210004463**
	550	1000	12,5	0,9	8210004464**
	550	2000	25	0,9	8210004465**
	600	500	7,25	0,9	8210004466**
	600	1000	14,5	0,9	8210004467**
	600	2000	29	0,9	8210004468**
	630	500	7,12	0,9	8210004469**
	630	1000	14,24	0,9	8210004470**
	630	2000	28,48	0,9	8210004471**

FB Duct

[image]	диаметр (mm)	Length (m)	Вес (кг)	Thickness (mm)	[model]
	650	2000	29,39	0,9	8210004474**
	700	500	7,91	0,9	8210004475**
	700	1000	15,82	0,9	8210004476**
	700	2000	31,64	0,9	8210004477**
	750	500	8,44	0,9	8210004478**
	750	1000	16,88	0,9	8210004479**
	750	2000	33,76	0,9	8210004480**
	800	500	9,04	0,9	8210004481**
	800	2000	36,16	0,9	8210004483**
	800	1000	18,08	0,9	8210004482**
	850	500	9,43	0,9	8210004484**
	850	1000	18,086	0,9	8210004485**
	850	2000	36,173	0,9	8210004486**
	900	500	10,19	0,9	8210004487**
	900	1000	20,32	0,9	8210004488**

FB Duct

[image]	диаметр (mm)	Length (m)	Вес (кг)	Thickness (mm)	[model]
	900	2000	40,76	0,9	8210004489**
	950	500	10,76	0,9	8210004490**
	950	1000	21,52	0,9	8210004491**
	950	2000	43,04	0,9	8210004492**
	1000	500	12	0,9	8210004493**
	1000	1000	24	0,9	8210004494**
	1000	2000	48	0,9	8210004495**

*Laser Welded

**Folded seam duct

FB Duct

	[accessory]	[partno]
	Quick release clip Ø=80 mm, with PVC lining	8210003082*
	Quick release clip Ø=100 mm, with PVC lining	8210003083*
	Quick release clip Ø=120 mm, with PVC lining	8210003084*
	Quick release clip Ø=125 mm, with PVC lining	8210003085*
	Quick release clip Ø=140 mm, with PVC lining	8210003086*
	Quick release clip Ø=150 mm, with PVC lining	8210003087*
	Quick release clip Ø=160 mm, with PVC lining	8210003088*
	Quick release clip Ø=180 mm, with PVC lining	8210003089*
	Quick release clip Ø=200 mm, with PVC lining	8210003090*
	Quick release clip Ø=225 mm, with PVC lining	8210003091*
	Quick release clip Ø=250 mm, with PVC lining	8210003092*
	Quick release clip Ø=280 mm, with PVC lining	8210003093*
	Quick release clip Ø=280 mm, Stainless, with PVC lining	FSAE-280-RS*
	Quick release clip Ø=300 mm, with PVC lining	8210003094*
	Quick release clip Ø=315 mm, with PVC lining	8210003095*
	Quick release clip Ø=325 mm, with PVC lining	FSAE-325*
	Quick release clip Ø=350 mm, with PVC lining	8210003096*
	Quick release clip Ø=400 mm, with PVC lining	8210003097*
	Quick release clip Ø=450 mm, with PVC lining	8210003098**
	Quick release clip Ø=500 mm, with PVC lining	8210003099**
	Quick release clip Ø=550 mm, with PVC lining	8210003100**
	Quick release clip Ø=600 mm, with PVC lining	8210003101**

FB Duct

	[accessory]	[partno]
	Clip FSAB Galv 80mm	8210003039
	Clip FSAB Galv 100mm	8210003040
	Clip FSAB Galv 120mm	8210003041
	Clip FSAB Galv 125mm	8210003042
	Clip FSAB Galv 140mm	8210003043
	Clip FSAB Galv 150mm	8210003044
	Clip FSAB Galv 160mm	8210003045
	Clip FSAB Galv 180mm	8210003046
	Clip FSAB Galv 200mm	8210003047
	Clip FSAB Galv 225mm	8210003048
	Clip FSAB Galv 280mm	8210003050
	Clip FSAB Galv 300mm	8210003051
	Clip FSAB Galv 315mm	8210003052
	Clip FSAB Galv 325mm	8210003053
	Clip FSAB Galv 350mm	8210003054
	Clip FSAB Galv 400mm	8210003055
	Clip FSAB Galv 450mm	8210003056
	Clip FSAB Galv 500mm	8210003057
	Wide Clip FSAD, Ø= 80 mm	8210003058***
	Wide Clip FSAD, Ø=100 mm	8210003059***
	Wide Clip FSAD, Ø=120 mm	8210003060***
	Wide Clip FSAD, Ø=125 mm	8210003061***











FB Duct

	[accessory]	[partno]
	Wide Clip FSAD, Ø=140 mm	8210003062***
	Wide Clip FSAD, Ø=150 mm	8210003063***
	Wide Clip FSAD, Ø=160 mm	8210003064***
	Wide Clip FSAD, Ø=180 mm	8210003065***
	Wide Clip FSAD, Ø=200 mm	8210003066
	Wide Clip FSAD, Ø=225 mm	8210003067
	Wide Clip FSAD, Ø=250 mm	8210003068
	Wide Clip FSAD, Ø=300 mm	8210003069
	Wide Clip FSAD, Ø=315 mm	8210003070
	Wide Clip FSAD, Ø=350 mm	8210003071
	Wide Clip FSAD, Ø=375 mm	FSAD-375
	Wide Clip FSAD, Ø=400 mm	8210003072
	Wide Clip FSAD, Ø=450 mm	8210003073
	Wide Clip FSAD, Ø=500 mm	8210003074
	Wide Clip FSAD, Ø=550 mm	8210003075
	Wide Clip FSAD, Ø=600 mm	8210003076
	Wide Clip FSAD, Ø=630 mm	8210003077
	Wide Clip FSAD, Ø=650 mm	8210003078
	Wide Clip FSAD, Ø=700 mm	8210003079
	Wide Clip FSAD, Ø=750 mm	8210003080
	Wide Clip FSAD, Ø=800 mm	8210003081
	Rubber gasket RSRS, f/FB egde Ø 80 mm, EPDM rubber	8210004347****









FB Duct

	[accessory]	[partno]
	Rubber gasket RSRS, f/FB egde Ø100 mm, EPDM rubber	8210004348****
	Rubber gasket RSRS, f/FB egde Ø120 mm, EPDM rubber	8210004349****
	Rubber gasket RSRS, f/FB egde Ø125 mm, EPDM rubber	8210004350****
	Rubber gasket RSRS, f/FB egde Ø140 mm, EPDM rubber	8210004351****
	Rubber gasket RSRS, f/FB egde Ø150 mm, EPDM rubber	8210004352****
	Rubber gasket RSRS, f/FB egde Ø160 mm, EPDM rubber	8210004353****
	Rubber gasket RSRS, f/FB egde Ø180 mm, EPDM rubber	8210004354****
	Rubber gasket RSRS, f/FB egde Ø200 mm, EPDM rubber	8210004355****
	Rubber gasket RSRS, f/FB egde Ø225 mm, EPDM rubber	8210004356****
	Rubber gasket RSRS, f/FB egde Ø250 mm, EPDM rubber	8210004357****
	Rubber gasket RSRS, f/FB egde Ø300 mm, EPDM rubber	8210004358****
	Rubber gasket RSRS, f/FB egde Ø315 mm, EPDM rubber	8210004359****
	Rubber gasket RSRS, f/FB egde Ø350 mm, EPDM rubber	8210004360****
	Rubber gasket RSRS, f/FB egde Ø375 mm, EPDM rubber	8210004361****
	Rubber gasket RSRS, f/FB egde Ø400 mm, EPDM rubber	8210004362****
	KVDA Split Strap Galv 3mm 80mm	8210001108
	KVDA Split Strap Galv 3mm 100mm	8210001109
	KVDA Split Strap Galv 3mm 120mm	8210001110
	KVDA Split Strap Galv 3mm 125mm	8210001111
	KVDA Split Strap Galv 3mm 140mm	8210001112
	KVDA Split Strap Galv 3mm 150mm	8210001113
	KVDA Split Strap Galv 3mm 160mm	8210001114

FB Duct

	[accessory]	[partno]
	KVDA Split Strap Galv 3mm 180mm	8210001115
	KVDA Split Strap Galv 3mm 200mm	8210001116
	KVDA Split Strap Galv 3mm 225mm	8210003376
	KVDA Split Strap Galv 3mm 250mm	8210001118
	KVDA Split Strap Galv 3mm 280mm	8210001119
	KVDA Split Strap Galv 3mm 300mm	8210001120
	KVDA Split Strap Galv 3mm 315mm	8210001121
	KVDA Split Strap Galv 3mm 325mm	8210001122
	KVDA Split Strap Galv 3mm 350mm	8210001123
	KVDA Split Strap Galv 3mm 400mm	8210001124
	KVDA Split Strap Galv 3mm 450mm	8210001125
	KVDA Split Strap Galv 3mm 500mm	8210001126
	KVDA Split Strap Galv 3mm 550mm	8210001127
	KVDA Split Strap Galv 3mm 560mm	8210001128
	KVDA Split Strap Galv 3mm 600mm	8210001129
	KVDA Split Strap Galv 3mm 630mm	8210001130
	KVDA Split Strap Galv 3mm 650mm	8210001131
	KVDA Split Strap Galv 3mm 710mm	8210001132
	KVDA Split Strap Galv 3mm 800mm	8210001133
	KVDD Legs for Split Strap Galv 80mm 160mm	8210003377
	KVDD Legs for Split Strap Galv 180mm 315mm	8210003378
	KVDD Legs for Split Strap Galv 350mm pair	8210003379

FB Duct

	[accessory]	[partno]
	KVDD Legs for Split Strap Galv 400mm pair	8210003380
	KVDD Legs for Split Strap Galv 450mm pair	8210003381
	KVDD Legs for Split Strap Galv 500mm pair	8210003382
	KVDD Legs for Split Strap Galv 550mm pair	8210003383
	KVDD Legs for Split Strap Galv 600mm pair	8210003384
	KVDD Legs for Split Strap Galv 650mm pair	8210003385
	KVDD Legs for Split Strap Galv 700mm pair	8210003386
	KVDD Legs for Split Strap Galv 800mm pair	8210003387

*Hinged Clip

**Bolted Clip

***Type I

****To be used in conjunction with FSAB Clips

FB Telescopic Duct

RSTA Telescopic Duct



Telescopic Duct is an important component as it allows you to quickly adjust the length of your duct run.

Наименование товара	FB Telescopic Duct
Length (m)	500
Пояснение к техническим данным	Laser Welded

FB Telescopic Duct

[Image]	Название листа технических данных	диаметр (мм)	Вес (кг)	Thickness (mm)	[model]
	Telescopic Duct Galv D=80 mm L= 500 mm, incl quicklock	80	1,06	0,7	8210004363*
	Telescopic Duct Galv D=140 mm L= 500 mm, incl quicklock	140	1,808	0,7	8210004367*
	Telescopic Duct Galv D=150 mm L= 500 mm, incl quicklock	150	1,948	0,7	8210004368*
	Telescopic Duct Galv D=160 mm L= 500 mm, incl quicklock	160	2,048	0,7	8210004369*
	Telescopic Duct Galv D=180 mm L= 500 mm, incl quicklock	180	2,048	0,7	8210004370*
	Telescopic Duct Galv D=200 mm L= 500 mm, incl quicklock	200	2,299	0,7	8210004371*
	Telescopic Duct Galv D=225 mm L= 500 mm, incl quicklock	225	2,53	0,7	8210004372*
	Telescopic Duct Galv D=250 mm L= 500 mm, incl quicklock	250	2,9	0,7	8210004373*
	Telescopic Duct Galv D=300 mm L= 500 mm, incl quicklock	300	3,754	0,7	8210004374*
	Telescopic Duct Galv D=315 mm L= 500 mm, incl quicklock	315	3,93	0,7	8210004375*
	Telescopic Duct Galv D=350 mm L= 500 mm, incl quicklock	350	4,52	0,7	8210004376*
	Telescopic Duct Galv D=400 mm L= 500 mm, incl quicklock	400	5,109	0,9	8210004377*

*Laser Welded

FB Pressed Bends

FB Pressed Bends with radius 1,5 x diameter to centerline.



Наименование товара

FB Pressed Bends

FB Pressed Bends

Название листа технических данных	диаметр (mm)	Вес (кг)	Radius	[model]
Pressed Bend BF 15°	80	0,1	120	8210002889
Pressed Bend BF 15°	100	0,2	150	8210002894
Pressed Bend BF 15°	120	0,4	180	8210002899
Pressed Bend BF 15°	125	0,4	188	8210002904
Pressed Bend BF 15°	140	0,4	210	8210002909
Pressed Bend BF 15°	150	0,4	225	8210002914
Pressed Bend BF 15°	160	0,4	240	8210002919
Pressed Bend BF 15°	180	0,5	270	8210002924
Pressed Bend BF 15°	200	0,7	300	8210002929
Pressed Bend BF 15°	224	0,9	336	8210002938
Pressed Bend BF 15°	250	0,9	375	8210002943
Pressed Bend BF 15°	275	0,9	413	8210002948
Pressed Bend BF 15°	300	1,3	450	8210002953
Pressed Bend BF 15°	315	0,9	472	8210002958
Pressed Bend BF 30°	80	0,2	120	8210002890
Pressed Bend BF 30°	100	0,3	150	8210002895
Pressed Bend BF 30°	120	0,3	180	8210002900
Pressed Bend BF 30°	125	0,3	188	8210002905
Pressed Bend BF 30°	140	0,4	210	8210002910
Pressed Bend BF 30°	150	0,5	225	8210002915
Pressed Bend BF 30°	160	0,5	240	8210002920
Pressed Bend BF 30°	180	0,7	270	8210002925
Pressed Bend BF 30°	200	0,7	300	8210002930
Pressed Bend BF 30°	220	1	330	8210002934
Pressed Bend BF 30°	224	1,3	336	8210002939
Pressed Bend BF 30°	250	1,5	375	8210002944
Pressed Bend BF 30°	275	1,85	413	8210002949
Pressed Bend BF 30°	300	2,2	450	8210002954
Pressed Bend BF 30°	315	2,2	472	8210002959
Pressed Bend BF 45°	80	0,2	120	8210002891
Pressed Bend BF 45°	100	0,3	150	8210002896
Pressed Bend BF 45°	120	0,4	180	8210002901
Pressed Bend BF 45°	125	0,4	188	8210002906
Pressed Bend BF 45°	140	0,5	210	8210002911
Pressed Bend BF 45°	150	0,5	225	8210002916
Pressed Bend BF 45°	160	0,6	240	8210002921
Pressed Bend BF 45°	180	1	270	8210002926
Pressed Bend BF 45°	200	1	300	8210002931
Pressed Bend BF 45°	220	1,6	330	8210002935
Pressed Bend BF 45°	224	1,6	336	8210002940
Pressed Bend BF 45°	250	1,6	375	8210002945
Pressed Bend BF 45°	275	1,8	413	8210002950
Pressed Bend BF 45°	300	2,3	450	8210002955
Pressed Bend BF 45°	315	2,4	472	8210002960
Pressed Bend BF 60°	80	0,3	120	8210002892
Pressed Bend BF 60°	100	0,4	150	8210002897
Pressed Bend BF 60°	120	0,6	180	8210002902
Pressed Bend BF 60°	125	0,6	188	8210002907
Pressed Bend BF 60°	140	0,7	210	8210002912
Pressed Bend BF 60°	150	0,7	225	8210002917
Pressed Bend BF 60°	160	0,7	240	8210002922
Pressed Bend BF 60°	180	1,2	270	8210002927
Pressed Bend BF 60°	200	1,3	300	8210002932
Pressed Bend BF 60°	220	1,7	330	8210002936
Pressed Bend BF 60°	224	1,7	336	8210002941
Pressed Bend BF 60°	250	1,9	375	8210002946
Pressed Bend BF 60°	275	2,15	413	8210002951
Pressed Bend BF 60°	300	2,4	450	8210002956
Pressed Bend BF 60°	315	2,5	472	8210002961
Pressed Bend BF 90°	80	0,4	120	8210002893
Pressed Bend BF 90°	100	0,5	150	8210002898
Pressed Bend BF 90°	120	0,8	180	8210002903
Pressed Bend BF 90°	125	0,8	188	8210002908

FB Pressed Bends

Название листа технических данных	диаметр (mm)	Вес (кг)	Radius	[model]
Pressed Bend BF 90°	140	1	210	8210002913
Pressed Bend BF 90°	150	1,1	225	8210002918
Pressed Bend BF 90°	160	1,2	240	8210002923
Pressed Bend BF 90°	180	1,6	270	8210002928
Pressed Bend BF 90°	200	1,9	300	8210002933
Pressed Bend BF 90°	220	2,4	330	8210002937
Pressed Bend BF 90°	224	2,4	336	8210002942
Pressed Bend BF 90°	250	3	375	8210002947
Pressed Bend BF 90°	275	3,1	413	8210002952
Pressed Bend BF 90°	300	3,2	450	8210002957
Pressed Bend BF 90°	315	5	472	8210002962

FB Segmented Bends

FB Segmented Bends with radius 1,5 x diameter to centerline



Наименование товара	FB Segmented Bends
Thickness (mm)	0,9

FB Segmented Bends

Название листа технических данных	диаметр (mm)	Вес (кг)	Radius	[model]
Segmented Bend FB 15°	350	1,23	525	8210002963
Segmented Bend FB 15°	400	1,68	600	8210002968
Segmented Bend FB 15°	450	2,31	675	8210002973
Segmented Bend FB 15°	500	3,29	750	8210002978
Segmented Bend FB 15°	550	3,6	825	8210002983
Segmented Bend FB 15°	600	3,78	900	8210002988
Segmented Bend FB 15°	630	3,98	945	8210002993
Segmented Bend FB 15°	650	4,18	975	8210002998
Segmented Bend FB 15°	700	4,47	1050	8210003003
Segmented Bend FB 15°	750	4,77	1125	8210003008
Segmented Bend FB 15°	800	5,16	1200	8210003013
Segmented Bend FB 15°	850	5,48	1275	8210003018
Segmented Bend FB 15°	900	5,8	1350	8210003023
Segmented Bend FB 15°	950	6,13	1425	8210003028
Segmented Bend FB 15°	1000	6,44	1500	8210003033
Segmented Bend FB 30°	350	2,18	525	8210002964
Segmented Bend FB 30°	400	2,66	600	8210002969
Segmented Bend FB 30°	450	3,63	675	8210002974
Segmented Bend FB 30°	500	4,52	750	8210002979
Segmented Bend FB 30°	550	5,9	825	8210002984
Segmented Bend FB 30°	600	6,38	900	8210002989
Segmented Bend FB 30°	630	6,58	945	8210002994
Segmented Bend FB 30°	650	6,78	975	8210002999
Segmented Bend FB 30°	700	7,39	1050	8210003004
Segmented Bend FB 30°	750	7,69	1125	8210003009
Segmented Bend FB 30°	800	8,46	1200	8210003014
Segmented Bend FB 30°	850	8,99	1275	8210003019
Segmented Bend FB 30°	900	9,51	1350	8210003024
Segmented Bend FB 30°	950	10,04	1425	8210003029
Segmented Bend FB 30°	1000	10,56	1500	8210003034
Segmented Bend FB 45°	350	3,35	525	8210002965
Segmented Bend FB 45°	400	4,11	600	8210002970
Segmented Bend FB 45°	450	5,59	675	8210002975
Segmented Bend FB 45°	500	6,95	750	8210002980
Segmented Bend FB 45°	550	9,04	825	8210002985
Segmented Bend FB 45°	600	9,91	900	8210002990
Segmented Bend FB 45°	630	10,11	945	8210002995
Segmented Bend FB 45°	650	10,31	975	8210003000
Segmented Bend FB 45°	700	11,37	1050	8210003005
Segmented Bend FB 45°	750	11,67	1125	8210003010
Segmented Bend FB 45°	800	12,96	1200	8210003015
Segmented Bend FB 45°	850	13,76	1275	8210003020
Segmented Bend FB 45°	900	14,56	1350	8210003025
Segmented Bend FB 45°	950	15,37	1425	8210003030
Segmented Bend FB 45°	1000	0,4	1500	8210003035
Segmented Bend FB 60°	350	4,53	525	8210002966
Segmented Bend FB 60°	400	5,56	600	8210002971
Segmented Bend FB 60°	450	7,55	675	8210002976
Segmented Bend FB 60°	500	9,37	750	8210002981
Segmented Bend FB 60°	550	12,18	825	8210002986
Segmented Bend FB 60°	600	13,44	900	8210002991
Segmented Bend FB 60°	630	13,64	945	8210002996
Segmented Bend FB 60°	650	13,84	975	8210003001
Segmented Bend FB 60°	700	15,35	1050	8210003006
Segmented Bend FB 60°	750	15,65	1125	8210003011
Segmented Bend FB 60°	800	17,46	1200	8210003016
Segmented Bend FB 60°	850	18,54	1275	8210003021
Segmented Bend FB 60°	900	19,62	1350	8210003026
Segmented Bend FB 60°	950	20,71	1425	8210003031
Segmented Bend FB 60°	1000	21,78	1500	8210003036
Segmented Bend FB 90°	350	6,89	525	8210002967
Segmented Bend FB 90°	400	8,47	600	8210002972
Segmented Bend FB 90°	450	11,47	675	8210002977

FB Segmented Bends

Название листа технических данных	диаметр (mm)	Вес (кг)	Radius	[model]
Segmented Bend FB 90°	500	14,21	750	8210002982
Segmented Bend FB 90°	550	18,46	825	8210002987
Segmented Bend FB 90°	600	20,5	900	8210002992
Segmented Bend FB 90°	630	20,7	945	8210002997
Segmented Bend FB 90°	650	20,9	975	8210003002
Segmented Bend FB 90°	700	23,31	1050	8210003007
Segmented Bend FB 90°	750	23,61	1125	8210003012
Segmented Bend FB 90°	800	26,45	1200	8210003017
Segmented Bend FB 90°	850	28,09	1275	8210003022
Segmented Bend FB 90°	900	29,72	1350	8210003027
Segmented Bend FB 90°	950	31,39	1425	8210003032
Segmented Bend FB 90°	1000	33,01	1500	8210003037

FB Branch

Branches (30 degrees) for FB ducting



Наименование товара	FB Branch
Пояснение к техническим данным	When ordering please define $\varnothing 1, \varnothing 2, \varnothing 3$ dimensions

FB Branch

Вес (кг)	Thickness (mm)	диаметр (1) (mm)	Diameter (2) (mm)	диаметр (3) (mm)	[model]
11,6	0,7	450	160	400	8240006420
0,8	0,7	80			GSAA-080*
0,8	0,7	80	80	80	8240005669
1,15	0,7	100			GSAA-100*
1,145	0,7	100	80	80	8240005670
1,145	0,7	100	80	100	8240005671
1,145	0,7	100	100	100	8240005672
1,45	0,7	120			GSAA-120*
1,25	0,7	120	80	120	8240005675
1,25	0,7	120	100	100	8240005676
1,25	0,7	120	100	120	8240005677
1,25	0,7	120	120	120	8240005678
1,45	0,7	125			GSAA-125*
1,4	0,7	125	80	125	8240005682
1,4	0,7	125	100	100	8240005683
1,4	0,7	125	100	125	8240005685
1,4	0,7	125	125	125	8240005688
1,8	0,7	140			GSAA-140*
1,8	0,7	140	80	140	8240005693
1,8	0,7	140	100	100	8240005694
1,8	0,7	140	120	140	8240005700
1,8	0,7	140	125	140	8240005702
1,8	0,7	140	140	140	8240005703
1,8	0,7	150			GSAA-150*
1,8	0,7	150	80	150	8240005709
1,8	0,7	150	100	150	8240005714
1,8	0,7	150	120	120	8240005715
1,8	0,7	150	120	150	8240005718
1,8	0,7	150	125	150	8240005721
1,8	0,7	150	150	150	8240005724
1,79	0,7	150			GSAA-160*
1,9	0,7	160	80	160	8240005731
1,9	0,7	160	100	100	8240005732
1,9	0,7	160	100	160	8240005737
1,9	0,7	160	120	160	8240005742
1,9	0,7	160	125	125	8240005743
1,9	0,7	160	125	160	8240005746
1,9	0,7	160	160	160	8240005752
2,5	0,7	180			GSAA-180*
2,2	0,7	180	80	180	8240005760
2,2	0,7	180	100	180	8240005767
2,2	0,7	180	120	180	8240005773
2,2	0,7	180	125	180	8240005778
2,2	0,7	180	150	180	8240005785
2,2	0,7	180	180	180	8240005788
2,5	0,7	200			GSAA-200*
2,9	0,7	200	80	200	8240005797
2,9	0,7	200	100	200	8240005805
2,9	0,7	200	120	200	8240005812
2,9	0,7	200	125	125	8240005813
2,9	0,7	200	125	200	8240005818
2,9	0,7	200	150	200	8240005827
2,9	0,7	200	160	160	8240005828
2,9	0,7	200	160	200	8240005830
3,5	0,7	200	200	200	8240005833
4,3	0,7	225			GSAA-225*
3,5	0,7	225	100	100	8240005844
3,5	0,7	225	100	225	8240005852
3,5	0,7	225	120	225	8240005860
3,5	0,7	225	125	225	8240005867
3,5	0,7	225	150	225	8240005878
3,5	0,7	225	160	225	8240005882
3,5	0,7	225	225	225	8240005888

FB Branch

Вес (кг)	Thickness (mm)	диаметр (1) (mm)	Diameter (2) (mm)	диаметр (3) (mm)	[model]
3,26	0,7	250			GSAA-250*
3,5	0,7	250	80	200	8240005897
3,5	0,7	250	80	250	8240005899
3,5	0,7	250	100	100	8240005900
3,5	0,7	250	100	250	8240005909
3,5	0,7	250	100	200	8240005907
3,5	0,7	250	120	200	8240005916
3,5	0,7	250	120	250	8240005918
3,5	0,7	250	125	200	8240005924
3,5	0,7	250	125	250	8240005926
3,5	0,7	250	150	200	8240005937
3,5	0,7	250	150	250	8240005939
3,5	0,7	250	160	160	8240005940
3,5	0,7	250	160	250	8240005944
3,5	0,7	250	200	250	8240005951
3,5	0,7	250	250	250	8240005954
5,5	0,7	300			GSAA-300*
4,5	0,7	300	80	300	GSAA-300830
4,5	0,7	300	100	300	8240006032
4,5	0,7	300	120	250	8240006041
4,5	0,7	300	120	300	8240006043
4,5	0,7	300	125	300	8240006053
4,5	0,7	300	150	300	8240006070
4,5	0,7	300	160	250	8240006075
4,5	0,7	300	160	300	8240006077
4,5	0,7	300	200	300	8240006088
4,5	0,7	300	300	300	8240006098
5,9	0,7	315			GSAA-315*
5,9	0,7	315	80	315	GSAA-320832
5,9	0,7	315	100	315	8240006111
5,9	0,7	315	120	315	8240006123
5,9	0,7	315	125	200	8240006129
5,9	0,7	315	125	250	8240006131
5,9	0,7	315	125	315	8240006134
5,9	0,7	315	150	315	8240006153
5,9	0,7	315	160	200	8240006156
5,9	0,7	315	315	315	8240006189
7,4	0,7	350			GSAA-350*
5,9	0,7	350	100	300	GSAA-351030
5,9	0,7	350	100	350	GSAA-351035
7,4	0,7	350	120	250	8240006198
7,4	0,7	350	120	300	8240006200
7,4	0,7	350	120	350	8240006202
7,4	0,7	350	125	250	8240006210
7,4	0,7	350	125	300	8240006212
7,4	0,7	350	125	350	8240006214
7,4	0,7	350	160	250	8240006158
7,4	0,7	350	160	315	8240006161
7,4	0,7	350	100	250	GSAA-351025
7,4	0,7	350	150	250	8240006231
7,4	0,7	350	150	300	8240006233
7,4	0,7	350	150	350	8240006235
7,4	0,7	350	160	250	8240006240
7,4	0,7	350	160	300	8240006242
7,4	0,7	350	160	350	8240006244
7,4	0,7	350	200	250	8240006255
7,4	0,7	350	200	350	8240006259
7,4	0,7	350	250	350	8240006270
7,4	0,7	350	350	350	8240006280
7,4	0,7	400			GSAA-400*
8,5	0,7	400	100	300	GSAA-401030
8,5	0,7	400	100	350	GSAA-401035
8,5	0,7	400	100	400	GSAA-401040

FB Branch

Вес (кг)	Thickness (mm)	диаметр (1) (mm)	Diameter (2) (mm)	диаметр (3) (mm)	[model]
8,5	0,7	400	120	400	8240006294
8,5	0,7	400	120	350	8240006293
8,5	0,7	400	125	300	8240006304
8,5	0,7	400	125	350	8240006306
8,5	0,7	400	125	400	8240006307
8,5	0,7	400	150	350	8240006329
8,5	0,7	400	150	400	8240006330
8,5	0,7	400	160	300	8240006337
8,5	0,7	400	160	350	8240006339
8,5	0,7	450	160	400	8240006340
8,5	0,7	450	200	300	8240006354
8,5	0,7	450	200	400	8240006357
8,5	0,7	400	225	300	8240006361
8,5	0,7	450	250	400	8240006370
8,5	0,7	400	315	400	8240006382
8,5	0,7	400	400	400	8240006385
11,68	0,7	450			GSAA-450*
11,6	0,7	450	100	400	GSAA-451040
11,6	0,7	450	100	450	GSAA-451045
11,6	0,7	450	100	450	GSAA-451245
11,6	0,7	450	125	400	GSAA-451340
11,6	0,7	450	125	450	GSAA-451345
11,6	0,7	450	150	350	8240006408
11,6	0,7	450	150	450	8240006410
11,6	0,7	450	160	350	8240006419
11,6	0,7	450	160	450	8240006421
11,6	0,7	450	200	400	8240006439
11,6	0,7	450	200	350	8240006438
11,6	0,7	450	200	450	8240006440
11,6	0,7	450	225	450	8240006448
11,6	0,7	450	250	400	8240006454
11,6	0,7	450	450	450	8240006476
12,5	0,7	500			GSAA-500*
12,5	0,7	500	100	500	GSAA-501050
12,5	0,7	500	120	500	GSAA-501250
12,5	0,7	500	125	450	GSAA-501345
12,5	0,7	500	125	500	GSAA-501350
12,5	0,7	500	150	500	8240006489
12,5	0,7	500	160	450	8240006500
12,5	0,7	500	160	500	8240006501
12,5	0,7	500	200	400	8240006520
12,5	0,7	500	200	450	8240006521
12,5	0,7	500	200	500	8240006522
12,5	0,7	500	225	450	8240006530
12,5	0,7	500	225	500	8240006531
12,5	0,7	500	250	450	8240006538
15	0,9	550			GSAA-550*
18	0,9	600			GSAA-600*
19	0,9	630			GSAA-630*
20	0,9	650			GSAA-650*
22	0,9	700			GSAA-700*
26	0,9	750			GSAA-750*
30	0,9	800			GSAA-800*

*When ordering please define Ø1,Ø2,Ø3 dimensions

FB Branch

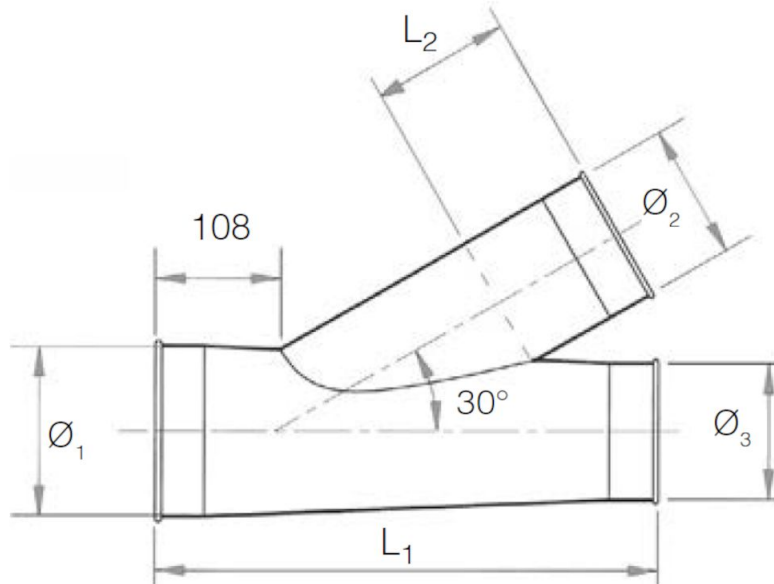

$$L_1 = (\varnothing_2 \times 2) + 236$$

$$L_2 = (\varnothing_2 / 2) + 58$$

\varnothing_3 must be smaller than or equal to \varnothing_1

\varnothing_2 must be smaller than or equal to \varnothing_3

FB Double Branch

Double branch forFB ducting



Наименование товара	FB Double Branch
Пояснение к техническим данным	When ordering please define $\varnothing 1, \varnothing 2, \varnothing 3, \varnothing 4$ dimensions

FB Double Branch

Вес (кг)	Thickness (mm)	диаметр (1) (mm)	[model]
1	0,7	80	GDAА-080*
1,7	0,7	100	GDAА-100*
2,33	0,7	120	GDAА-120*
2,5	0,7	125	GDAА-125*
3,03	0,7	140	GDAА-140*
3,41	0,7	150	GDAА-150*
3,18	0,7	160	GDAА-160*
3,91	0,7	180	GDAА-180*
4,71	0,7	200	GDAА-200*
5,82	0,7	225	GDAА-225*
7,05	0,7	250	GDAА-250*
9,84	0,7	300	GDAА-300*
10,77	0,7	315	GDAА-315*
15,72	0,9	350	GDAА-350*
20,19	0,9	400	GDAА-400*
25,21	0,9	450	GDAА-450*
30,78	0,9	500	GDAА-500*
36,91	0,9	550	GDAА-550*
43,59	0,9	600	GDAА-600*
47,87	0,9	630	GDAА-630*
50,83	0,9	650	GDAА-650*
58,62	0,9	700	GDAА-700*
66,97	0,9	750	GDAА-750*
75,87	0,9	800	GDAА-800*

*When ordering please define Ø1,Ø2,Ø3,Ø4 dimensions

FB Double Branch

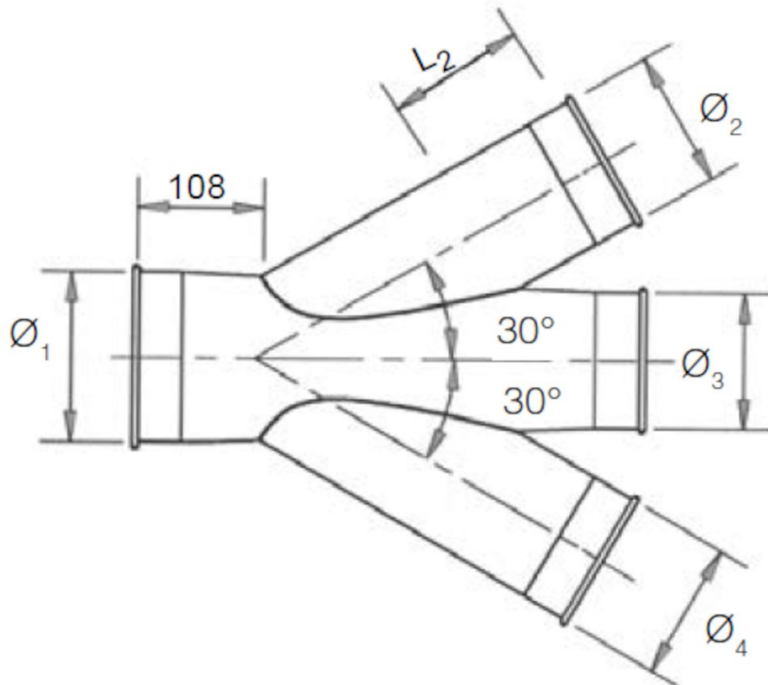

$$L_1 = (\varnothing_2 \times 2) + 236,$$

$$L_2 = (\varnothing_2 / 2) + 58,$$

\varnothing_3 must be smaller than or equal to \varnothing_1 ,

\varnothing_2 must be smaller than or equal to \varnothing_3 ,

\varnothing_4 must be smaller than or equal to \varnothing_3

FB Y-Branch

Y-Branched for FB ducting



Наименование товара	FB Y-Branch
Пояснение к техническим данным	When ordering please define $\varnothing 1, \varnothing 2$ dimensions

FB Y-Branch

Вес (кг)	Thickness (mm)	диаметр (1) (mm)	Diameter (2) (mm)	диаметр (3) (mm)	[model]
0,4	0,7				HSAA-080*
0,4	0,7	80	80	80	8240007278
0,4	0,7	80	54 rk	54 rk	HSAA-085454
0,6	0,7	100			HSAA-100*
0,6	0,7	100	80	80	8240007279
0,6	0,7	100	100	100	8240007280
0,8	0,7				HSAA-120*
0,8	0,7	120	100	100	8240007282
0,8	0,7	120	120	120	8240007283
0,8	0,7				HSAA-125*
0,8	0,7	125	80	0	8240007284
0,8	0,7	125	100	80	HSAA-131008
0,8	0,7	125	100	100	8240007285
0,8	0,7	125	125	125	8240007287
0,9	0,7				HSAA-140*
0,9	0,7	140	140	140	8240007292
1	0,7				HSAA-150*
1	0,7	150	100	100	8240007294
1	0,7	150	125	125	8240007296
1	0,7	150	150	150	8240007298
1,1	0,7				HSAA-160*
1,1	0,7	160	100	100	8240007300
1,1	0,7	160	125	125	8240007302
1,1	0,7	160	160	160	8240007305
1,3	0,7				HSAA-180*
1,3	0,7	180	180	180	8240007313
1,8	0,7				HSAA-200*
1,8	0,7	200	160	160	8240007320
1,8	0,7	200	200	200	8240007322
2,2	0,7				HSAA-225*
2,2	0,7	225	225	225	8240007332
2,5	0,7				HSAA-250*
2,5	0,7	250	160	160	8240007339
2,5	0,7	250	200	200	8240007341
2,5	0,7	250	250	250	8240007343
2,8	0,7				HSAA-300*
2,8	0,7	300	200	200	8240007362
2,8	0,7	300	250	250	8240007364
2,8	0,7	300	300	300	8240007366
2,9	0,7				HSAA-315*
2,9	0,7	315	200	200	8240007374
2,9	0,7	315	250	250	8240007376
2,9	0,7	315	315	315	8240007379
3,8	0,7				HSAA-350*
4,3	0,7				HSAA-400*
5,5	0,7				HSAA-450*
6,1	0,7				HSAA-500*
7,8	0,9				HSAA-550*
8,5	0,9				HSAA-600*
9,5	0,9				HSAA-630*
12	0,9				HSAA-650*
13	0,9				HSAA-700*
16	0,9				HSAA-750*
19	0,9				HSAA-800*

*When ordering please define Ø1,Ø2 dimensions

FB Y-Branch

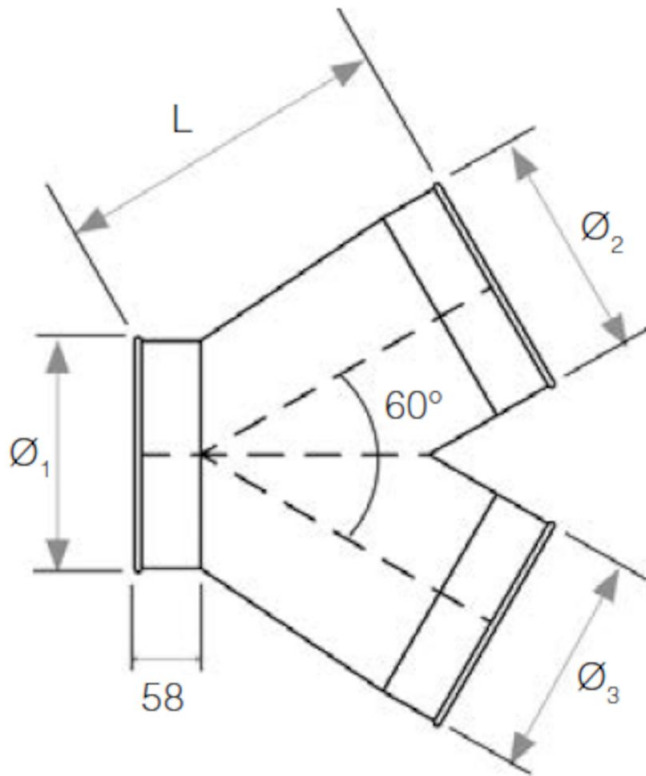

$L = \varnothing_1 + 100$,
 \varnothing_2 and \varnothing_3 must be smaller than or equal to \varnothing_1

FB Cut-In Branch

Cut-In Branches for FB ducting



Наименование товара	FB Cut-In Branch
Пояснение к техническим данным	When ordering please define $\varnothing 1, \varnothing 2$ dimensions

FB Cut-In Branch

Вес (кг)	Thickness (mm)	диаметр (1) (mm)	Diameter (2) (mm)	[model]
0,6	0,7	80		GSAP-080*
0,6	0,7	80	80	8240005154
0,83	0,7	100		GSAP-100*
0,83	0,7	100	80	8240005155
0,83	0,7	100	100	8240005156
1,1	0,7	120		GSAP-120*
1,1	0,7	120	80	8240005157
1,1	0,7	120	100	8240005158
1,1	0,7	120	120	8240005159
1,1	0,7	125	125	GSAP-125*
1,1	0,7	125	80	8240005160
1,1	0,7	125	100	8240005161
1,1	0,7	125	125	8240005163
1,4	0,7	140		GSAP-140*
1,4	0,7	140	80	8240005164
1,4	0,7	140	100	8240005165
1,4	0,7	140	120	8240005166
1,4	0,7	140	125	8240005167
1,4	0,7	140	140	8240005168
1,56	0,7	150		GSAP-150*
1,56	0,7	150	80	8240005169
1,56	0,7	150	100	8240005170
1,56	0,7	150	120	8240005171
1,56	0,7	150	125	8240005172
1,56	0,7	150	150	8240005174
1,73	0,7	160		GSAP-160*
1,73	0,7	160	80	8240005175
1,73	0,7	160	100	8240005176
1,73	0,7	160	120	8240005177
1,73	0,7	160	125	8240005178
1,73	0,7	160	150	8240005180
1,73	0,7	160	160	8240005181
2,1	0,7	180		GSAP-180*
2,1	0,7	180	80	8240005182
2,1	0,7	180	100	8240005183
2,1	0,7	180	120	8240005184
2,1	0,7	180	125	8240005185
2,1	0,7	180	160	8240005188
2,1	0,7	180	180	8240005189
2,51	0,7	200		GSAP-200*
2,51	0,7	200	80	8240005190
2,51	0,7	200	100	8240005191
2,51	0,7	200	120	8240005192
2,51	0,7	200	125	8240005193
2,51	0,7	200	150	8240005195
2,51	0,7	200	160	8240005196
2,51	0,7	200	200	8240005198
2,51	0,7	225		GSAP-225*
2,51	0,7	225	80	8240005199
2,51	0,7	225	100	8240005200
2,51	0,7	225	120	8240005201
2,51	0,7	225	125	8240005202
2,51	0,7	225	150	8240005204
2,51	0,7	225	160	8240005205
2,51	0,7	225	200	8240005207
3,68	0,7	250		GSAP-250*
3,68	0,7	250	80	8240005209
3,68	0,7	250	120	8240005211
3,68	0,7	250	125	8240005212
3,68	0,7	250	150	8240005214
3,68	0,7	250	160	8240005215
3,68	0,7	250	180	8240005216
3,68	0,7	250	200	8240005217

FB Cut-In Branch

Вес (кг)	Thickness (mm)	диаметр (1) (mm)	Diameter (2) (mm)	[model]
5,06	0,7	300		GSAP-300*
5,06	0,7	300	80	8240005232
5,06	0,7	300	100	8240005233
5,06	0,7	300	120	8240005234
5,06	0,7	300	125	8240005235
5,06	0,7	300	150	8240005237
5,06	0,7	300	160	8240005238
5,06	0,7	300	180	8240005239
5,06	0,7	300	200	8240005240
5,52	0,7	315		GSAP-315*
5,52	0,7	315	80	8240005245
5,52	0,7	315	100	8240005246
5,52	0,7	315	125	8240005248
5,52	0,7	315	150	8240005250
5,52	0,7	315	160	8240005251
5,52	0,7	315	180	8240005252
5,52	0,7	315	120	8240005247
5,52	0,7	350	100	8240005260
5,52	0,7	315	200	8240005253
8,58	0,9	350		GSAP-350*
8,58	0,9	350	80	8240005259
8,58	0,9	350	120	8240005261
8,58	0,9	350	125	8240005262
8,58	0,9	350	150	8240005264
8,58	0,9	350	160	8240005265
8,58	0,9	350	180	8240005266
8,58	0,9	350	200	8240005267
10,93	0,9	400		GSAP-400*
10,93	0,9	400	80	GSAP-400-080
10,93	0,9	400	100	8240005274
10,93	0,9	400	160	8240005279
13,56	0,9	400	120	8240005275
13,56	0,9	400	125	8240005276
13,56	0,9	400	150	8240005278
13,56	0,9	400	180	8240005280
13,56	0,9	400	200	8240005281
13,56	0,9	450		GSAP-450*
13,56	0,9	450	80	GSAP-450-080
13,56	0,9	450	100	GSAP-450-100
13,56	0,9	450	120	8240005289
13,56	0,9	450	125	8240005290
13,56	0,9	450	150	8240005292
13,56	0,9	450	160	8240005293
13,56	0,9	450	180	8240005294
13,56	0,9	450	200	8240005295
16,48	0,9	500		GSAP-500*
16,48	0,9	500	80	GSAP-500-080
16,48	0,9	500	100	GSAP-500-100
16,48	0,9	500	120	GSAP-500-120
16,48	0,9	500	125	8240005304
16,48	0,9	500	150	8240005306
16,48	0,9	500	160	8240005307
16,48	0,9	500	180	8240005308
16,48	0,9	500	200	8240005309*
19,68	0,9	550	550	GSAP-550*
25,39	0,9	630	630	GSAP-630

*When ordering please define Ø1,Ø2 dimensions

FB Cut-In Branch

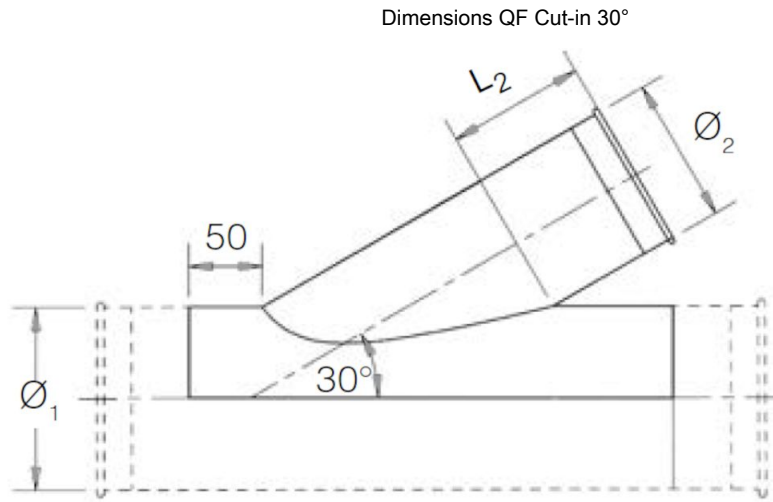

$$L_2 = (\varnothing_2 / 2) + 58,$$

\varnothing_2 must be smaller than or equal to \varnothing_1

FB Reducer

Reducer for a FB duct system



Наименование товара	FB Reducer
Пояснение к техническим данным	When ordering please specify Ø1,Ø2 dimensions.

FB Reducer

[image]	Вес (кг)	Thickness (mm)	диаметр (1) (mm)	Diameter (2) (mm)	[model]
	0,4	0,7			RRGS-100*
	0,4	0,7	100	80	8240005424
	0,424	0,7			RRGS-120*
	0,424	0,7	120	80	8240005425
	0,424	0,7	120	100	8240005426
	0,436	0,7			RRGS-125*
	0,4432	0,7	125	100	8240005428
	0,4504	0,7	125	120	8240005429
	0,46	0,7			RRGS-140*
	0,46	0,7	140	80	8240005430
	0,46	0,7	140	100	8240005431
	0,46	0,7	140	120	8240005432
	0,46	0,7	140	125	8240005433
	0,5	0,7			RRGS-150*
	0,5	0,7	150	80	8240005434

FB Reducer

[image]	Вес (кг)	Thickness (mm)	диаметр (1) (mm)	Diameter (2) (mm)	[model]
	0,5	0,7	150	100	8240005435
	0,5	0,7	150	120	8240005436
	0,5	0,7	150	125	8240005437
	0,5	0,7	150		8240005438
	0,55	0,7			RRGS-160*
	0,55	0,7	160	80	8240005439
	0,55	0,7	160	100	8240005440
	0,55	0,7	160	120	8240005441
	0,55	0,7	160	125	8240005442
	0,55	0,7	160	150	8240005444
	0,65	0,7			RRGS-180*
	0,65	0,7	180	80	8240005445
	0,65	0,7	180	100	8240005446
	0,65	0,7	180	120	8240005447
	0,65	0,7	180	125	8240005448

FB Reducer

[image]	Вес (кг)	Thickness (mm)	диаметр (1) (mm)	Diameter (2) (mm)	[model]
	0,65	0,7	180		8240005449
	0,65	0,7	180		8240005450
	0,65	0,7	180		8240005451
	0,7	0,7			RRGS-200*
	0,7	0,7	200	80	8240005452
	0,7	0,7	200	120	8240005454
	0,7	0,7	200	125	8240005455
	0,7	0,7	200	140	8240005456
	0,7	0,7	200	150	8240005457
	0,7	0,7	200	160	8240005458
	0,7	0,7	200	180	8240005459
	0,85	0,7			RRGS-225*
	0,85	0,7	225	100	8240005461
	0,85	0,7	225	120	8240005462
	0,85	0,7	225	125	8240005463

FB Reducer

[image]	Вес (кг)	Thickness (mm)	диаметр (1) (mm)	Diameter (2) (mm)	[model]
	0,85	0,7	225	140	8240005464
	0,85	0,7	225	150	8240005465
	0,85	0,7	225	160	8240005466
	0,85	0,7	225	180	8240005467
	0,85	0,7	225	200	8240005468
	0,85	0,7			RRGS-250*
	0,85	0,7	250	80	8240005469
	0,85	0,7	250	100	8240005470
	0,85	0,7	250	150	8240005474
	0,85	0,7	250	160	8240005475
	0,85	0,7	250	180	8240005476
	0,85	0,7	250	200	8240005477
	0,85	0,7	250	225	8240005478
	0,9	0,7			RRGS-275*
	0,95	0,7		225	RRGS-300*

FB Reducer

[image]	Вес (кг)	Thickness (mm)	диаметр (1) (mm)	Diameter (2) (mm)	[model]
	0,95	0,7	300	150	8240005495
	0,95	0,7	300	160	8240005496
	0,95	0,7	300	180	8240005497
	0,95	0,7	300	200	8240005498
	0,95	0,7	300	225	8240005499
	0,95	0,7	300	250	8240005500
	1,1	0,7			RRGS-315*
	1,1	0,7	315	150	8240005507
	1,1	0,7	315	160	8240005508
	1,1	0,7	315	180	8240005509
	1,1	0,7	315	200	8240005510
	1,1	0,7	315	225	8240005511
	1,1	0,7	315	250	8240005512
	1,1	0,7	315	300	8240005514
	1,125	0,9			RRGS-350*

FB Reducer

[image]	Вес (кг)	Thickness (mm)	диаметр (1) (mm)	Diameter (2) (mm)	[model]
	1,125	0,9	350	150	8240005520
	1,125	0,9	350	160	8240005521
	1,125	0,9	350	180	8240005522
	1,125	0,9	350	200	8240005523
	1,125	0,9	350	225	8240005524
	1,125	0,9	350	250	8240005525
	1,125	0,9	350	300	8240005527
	1,125	0,9	350	315	8240005528
	1,215	0,9			RRGS-400*
	1,215	0,9	400	200	8240005536
	1,215	0,9	400	225	8240005537
	1,215	0,9	400	250	8240005538
	1,215	0,9	400	300	8240005540
	1,215	0,9	400	315	8240005541
	1,215	0,9	400	350	8240005542

FB Reducer

[image]	Вес (кг)	Thickness (mm)	диаметр (1) (mm)	Diameter (2) (mm)	[model]
	2,92	0,9			RRGS-450*
	1,35	0,9	450	200	8240005549
	1,35	0,9	450	225	8240005550
	1,35	0,9	450	250	8240005551
	1,35	0,9	450	300	8240005553
	1,35	0,9	450	315	8240005554
	1,35	0,9	450	350	8240005555
	1,35	0,9	450	400	8240005556
	4	0,9			RRGS-500*
	2,11	0,9	500	200	8240005562
	2,11	0,9	500	225	8240005563
	2,11	0,9	500	250	8240005564
	2,11	0,9	500	300	8240005566
	2,11	0,9	500	315	8240005567
	2,11	0,9	500	350	8240005568

FB Reducer

[image]	Вес (кг)	Thickness (mm)	диаметр (1) (mm)	Diameter (2) (mm)	[model]
	2,11	0,9	500	400	8240005569
	2,11	0,9	500	450	8240005570
	4	0,9			RRGS-550*
	5	0,9			RRGS-600*
	6	0,9			RRGS-630*
	7	0,9			RRGS-650*
	7,2	0,9			RRGS-700*
	7,5	0,9			RRGS-750*
	8	0,9			RRGS-800*
	0,3	0,7			RRGL-080*
	0,3	0,7	80	50	RRGL-080-050
	0,3	0,7	80	54	RRGL-080-054
	0,3	0,7	80	60	RRGL-080-060
	0,3	0,7	80	76	RRGL-080-076
	0,36	0,7			RRGL-100*

FB Reducer

[image]	Вес (кг)	Thickness (mm)	диаметр (1) (mm)	Diameter (2) (mm)	[model]
	0,36	0,7	100	50	RRGL-100-050
	0,36	0,7	100	60	RRGL-100-060
	0,36	0,7	100	80	RRGL-100-080
	0,44	0,7			RRGL-120*
	0,46	0,7			RRGL-125*
	0,52	0,7			RRGL-140*
	0,56	0,7			RRGL-150*
	0,6	0,7			RRGL-160*
	0,66	0,7			RRGL-180*
	0,74	0,7			RRGL-200*
	0,78	0,7			RRGL-225*
	0,96	0,7			RRGL-250*
	1,21	0,7			RRGL-300*
	1,23	0,7			RRGL-315*
	1,31	0,9			RRGL-350*

FB Reducer

[image]	Вес (кг)	Thickness (mm)	диаметр (1) (mm)	Diameter (2) (mm)	[model]
	1,63	0,9			RRGL-400*
	1,83	0,9			RRGL-450*
	2,64	0,9			RRGL-500*
	3,065	0,9			RRGL-550*
	3,072	0,9			RRGL-600*
	3,072	0,9			RRGL-630*
	3,072	0,9			RRGL-650*
	4,875	0,9			RRGL-700*
	4,875	0,9			RRGL-750*
	5	0,9			RRGL-800*

*When ordering please specify $\varnothing 1, \varnothing 2$ dimensions.



FB Adapters and Accessories

Adapters and various accessories for FB ducting systems



Наименование товара	FB Adapters and Accessories
---------------------	-----------------------------

FB Adapters and Accessories

[image]	Бес (κ)	Thickness (mm)	[model]
	0,104		8210003822
	0,129		8210003823
	0,155		8210003824
	0,162		8210003825
	0,181		8210003826
	0,194		8210003827
	0,207		8210003828
	0,233		8210003829
	0,259		8210003830
	0,291		8210003831
	0,324		8210003832
	0,356		8210003833
	0,388		8210003834
	0,408		8210003835
	0,21		8210003802

FB Adapters and Accessories

[image]	Бес (κ)	Thickness (mm)	[model]
	0,31		8210003803
	0,38		8210003804
	0,44		8210003805
	0,47		8210003806
	0,53		8210003807
	0,63		8210003808
	0,58		8210003809
	0,66		8210003810
	0,74		8210003811
	0,79		8210003812
	0,92		8210003813
	1,02		8210003814
	1,125		8210003815
	1,25		8210003816
	1,45		8210003817

FB Adapters and Accessories

[image]	Βεc (κ)	Thickness (mm)	[model]
	1,6		8210003818
	1,8		8210003819
	1,9		8210003820
	2		8210003821
	0,16		8210003836
	0,2		8210003837
	0,24		8210003838
	0,24		8210003839
	0,27		8210003840
	0,29		8210003841
	0,31		8210003842
	0,35		8210003843
	0,39		8210003844
	0,44		8210003845
	0,49		8210003846

FB Adapters and Accessories

[image]	Βεc (κ)	Thickness (mm)	[model]
	0,59		8210003847
	0,62		8210003848
	0,82		8210003849
	0,94		8210003850
	1,06		8210003851
	1,48		8210003852
	1,18		8210003853
	1,29		8210003854
	1,41		8210003855
	0,04	0,9	8210003407
	0,06	0,9	8210003408
	0,09	0,9	8210003409
	0,09	0,9	8210003410
	0,12	0,9	8210003411
	0,13	0,9	8210003412

FB Adapters and Accessories

[image]	Βεc (κ)	Thickness (mm)	[model]
	0,15	0,9	8210003413
	0,19	0,9	8210003414
	0,28	0,9	8210003415
	0,36	0,9	8210003416
	0,44	0,9	8210003417
	0,64	0,9	8210003418
	0,7	0,9	8210003419
	0,87	0,9	8210003420
	1,13	0,9	8210003421
	1,43	0,9	8210003422
	1,77	0,9	8210003423
	0,881	1,25	8210003738
	1,058	1,25	8210003739
	1,217	1,25	8210003740
	1,279	1,25	8210003741

FB Adapters and Accessories

[image]	Βεc (κ)	Thickness (mm)	[model]
	1,41	1,25	8210003742
	1,503	1,25	8210003743
	1,48	1,25	8210003744
	1,68	1,25	8210003745
	1,82	1,25	8210003746
	2,04	1,25	8210003747
	2,25	1,25	8210003748
	2,68	1,25	8210003749
	3,88	1,25	8210003750
	3,98	1,25	8210003751
	4,6	1,25	8210003752
	5,25	1,25	8210003753
	5,66	1,25	8210003754
	6,25	1,25	8210003755
	7,35	1,25	8210003756

FB Adapters and Accessories

[image]	Βεc (κ)	Thickness (mm)	[model]
	7,22	1,25	8210003757
	2,5		8210003758
	2,95		8210003759
	3,11		8210003760
	3,94		8210003761
	3,99		8210003762
	4,5		8210003763
	5,02		8210003764
	6,28		8210003765
	7,54		8210003766
	7,91		8210003767

По вопросам продаж и поддержки обращайтесь:

Алматы (7273)495-231	Казань (843)206-01-48	Новокузнецк (3843)20-46-81	Смоленск (4812)29-41-54
Архангельск (8182)63-90-72	Калининград (4012)72-03-81	Новосибирск (383)227-86-73	Сочи (862)225-72-31
Астрахань (8512)99-46-04	Калуга (4842)92-23-67	Омск (3812)21-46-40	Ставрополь (8652)20-65-13
Барнаул (3852)73-04-60	Кемерово (3842)65-04-62	Орел (4862)44-53-42	Сургут (3462)77-98-35
Белгород (4722)40-23-64	Киров (8332)68-02-04	Оренбург (3532)37-68-04	Тверь (4822)63-31-35
Брянск (4832)59-03-52	Краснодар (861)203-40-90	Пенза (8412)22-31-16	Томск (3822)98-41-53
Владивосток (423)249-28-31	Красноярск (391)204-63-61	Пермь (342)205-81-47	Тула (4872)74-02-29
Волгоград (844)278-03-48	Курск (4712)77-13-04	Ростов-на-Дону (863)308-18-15	Тюмень (3452)66-21-18
Вологда (8172)26-41-59	Липецк (4742)52-20-81	Рязань (4912)46-61-64	Ульяновск (8422)24-23-59
Воронеж (473)204-51-73	Магнитогорск (3519)55-03-13	Самара (846)206-03-16	Уфа (347)229-48-12
Екатеринбург (343)384-55-89	Москва (495)268-04-70	Санкт-Петербург (812)309-46-40	Хабаровск (4212)92-98-04
Иваново (4932)77-34-06	Мурманск (8152)59-64-93	Саратов (845)249-38-78	Челябинск (351)202-03-61
Ижевск (3412)26-03-58	Набережные Челны (8552)20-53-41	Севастополь (8692)22-31-93	Череповец (8202)49-02-64
Иркутск (395)279-98-46	Нижний Новгород (831)429-08-12	Симферополь (3652)67-13-56	Ярославль (4852)69-52-93
Россия (495)268-04-70	Киргизия (996)312-96-26-47	Казахстан (7172)727-132	